

PRO PAR 9BTIP



This product manual contains important information about the safe installation and use of this projector. Please read and follow these instructions carefully and keep this manual in a safe place for future reference.

6CH Mode

	Value	Description
CH1	0	No action
	1-255	RED dimmer
CH2	0	No action
	1-255	GREEN dimmer
CH3	0	No action
	1-255	BLUE dimmer
CH4	0	No action
	1-255	WHITE dimmer
CH5	0	No action
	1-255	AMBER dimmer
CH6	0	No action
	1-255	UV dimmer

10CH Mode

	Value	Description
CH1	0	No action
	1-255	RGBAW+UV dimmer
CH2	0-4	No action
	5-255	Strobe from slow to fast
CH3	0	No function
	1-255	Red dimmer
CH4	0	No function
	1-255	Green dimmer
CH5	0	No function
	1-255	Blue dimmer
CH6	0	No function
	1-255	White dimmer
CH7	0	No function
	1-255	Amber dimmer
CH8	0	No function
	1-255	UV dimmer
CH9	0-4	No function
	5-80	Color macro

	81-150	Color jump
	151-220	Color fade
	221-255	Sound active
CH10	0	No function
	1-255	Speed from slow to fast

LCD Operation Menu:

DMX Address 001-507(6CH) 001-503(10CH)

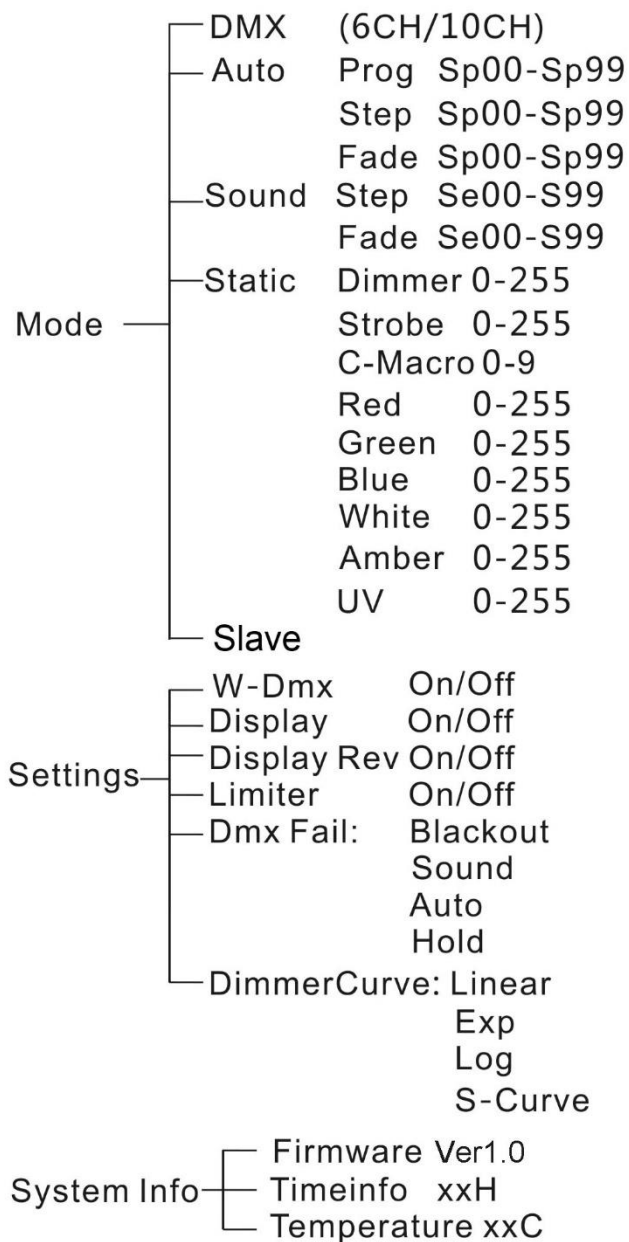

There are two buttons on the rear panel of the lighting. One is for power, and the other is for signal.

- When use the fixture with DMX, not wireless, please switch the signal button for “off”
- When use the wireless DMX, please switch the button for “on”
- When charge the light, please switch both of the button for “of”. At the same time, if the switch for power is “on”, the light will be at work during the process of charge, but will consume some power from the charge; if the switch for power is “off”, the light will be blackout and not be at work.

Tip for the battery and charge:

- The battery can last for 4-5 hours when all LEDs on after full charge , and can last for more than 6-8 hours on auto running mode. Up to 20 Hours with one color diode on. Results will vary based on brightness of LEDs
- It is suggested to charge the battery for at least 4 hours, which will extend the life span of the battery.

Most important: FIRST CHARGE THE FIXTURES FOR 6-8 Hours on the First Charge before use. Plug in Power cord. Turn off Power Switch and Turn off other switch to charge.

Introduction

Unpacking: Thank you for purchasing this product, all products has been thoroughly tested and has been shipped in perfect operating condition. Carefully check the shipping carton for damage that may have occurred during shipping. If the carton appears to be damaged, carefully inspect your fixture for any damage and be sure all accessories necessary to operate the unit has arrived intact. In the case damage has been found or parts are missing, please contact the manufacturer or your dealer for further instructions. Do not return this unit to your dealer without first contacting.

Introduction: this lighting is a DMX intelligent and battery powered LED par light. This par light is light weight and compact which makes it a great piece for mobile DJ”s and clubs.

Warning! To prevent or reduce the risk of electrical shock or fire, do not expose this unit to rain or moisture.

Caution! There are no user serviceable parts inside this unit. Do not attempt any repairs yourself; doing so will void your manufactures warranty. In the unlikely event your unit may require service please contact the manufacturer or your dealer.

PLEASE recycle the shipping carton whenever possible.

General Instructions

To optimize the performance of this product, please read these operating instructions carefully to familiarize you with the basic operations of this unit. These instructions contain important safety information regarding the use and maintenance of this unit. Please keep this manual with the unit, for future reference.



Features

- Power supply: AC110V-250V
- Frequency: 50-60Hz
- Power consumption: 140W

- Light source: 9pcs 15W high brightness 6 in 1 leds
- Lamp life: 6-10 ten thousand hrs
- LED angle: 15 degree
- Color: 16.7 million kinds of color change
- Control channels: 6/10 chs
- Control mode: DMX512, master/slave, auto, sound active
- Automatic model(by function button) : color change, color strobe, color dimmer, color gradual change/color jump change
- Operation menu: LCD display
- Packing size: 290*290*330mm
- N.W: 6kg
- G.W: 6.5kg

Safety Precautions

- To reduce the risk of electrical shock or fire, do not expose this unit to rain or moisture.
- Do not spill water or other liquids into or on to your unit.
- Be sure that the local power outlet match that of the required voltage for your unit.
- Do not attempt to operate this unit if the power cord has been frayed or broken. Do not attempt to remove or break off the ground prong from the electrical cord. This prong is used to reduce the risk of electrical shock and fire in case of an internal short.
- Disconnect from main power before making any type of connection.
- Do not remove the cover under any conditions. There are no user serviceable parts inside.
- Never operate this unit when it's cover is removed.
- Never plug this unit in to a dimmer pack.
- Always be sure to mount this unit in an area that will allow proper ventilation. Allow about 6" (15cm) between this device and a wall.
- Do not attempt to operate this unit, if it becomes damaged.
- This unit is intended for indoor use only; use of this product outdoors voids all warranties.
- During long periods of non-use, disconnect the unit's main power.
- Always mount this unit in safe and stable matter.
- Power-supply cords should be routed so that they are not likely to be walked on or pinched by items placed upon or against them, paying particular attention to the point they exit from unit.
- Cleaning -The fixture should be cleaned only as recommended by the manufacturer. See "Cleaning" for details.
- Heat -The appliance should be situated away from heat sources such as radiators, heat registers, stoves, or other appliances (including amplifiers) that produce heat.
- The fixture should be serviced by qualified service personnel when:
 - A. The power-supply cord or the plug has been damaged.
 - B. Objects have fallen, or liquid has been spilled into the appliance.
 - C. The appliance has been exposed to rain or water.
 - D. The appliance does not appear to operate normally or exhibits a marked change in performance

Infrared function

Infrared Mode Infrared (IR) mode allows the product to be controlled with an infrared remote controller. The IRC-6 can remotely set the product to various modes; adjust the color, speed and sensitivity; and set the strobe. The Par is compatible with the included IRC-6. To enable use with the IRC-6, follow the instructions below:

1. Press <MENU> repeatedly until **SET** shows on the display.
2. Press <ENTER> and **On** (turns on the infrared sensor) or **OFF** (turns off the infrared sensor) shows on the display.
3. Press <UP> or <DOWN> to select the desired option.
4. Press <ENTER>.

IRC-6 Operations Be sure the IRC-6 remote is pointing directly at the product and there is nothing in between the remote and the product.



Automatic Mode

Automatic mode will enable you to run the automatic programs on the product.

To turn on Automatic mode:

1. Press <AUTO> on the IRC-6.
2. Press <+> or <-> to choose between the four different auto programs.

To adjust the speed of the automatic program:

1. Press <SPEED> on the IRC-6.
2. Press <%>.
3. Press <+> or <-> to either increase or decrease the speed of the program.

Sound-Active Mode

Sound-Active mode will enable the product to respond to the music.

To turn on Sound-Active mode:

- Press <SOUND> on the IRC-6.

To adjust sound sensitivity in Sound-Active mode:

1. Press <SENSITIVITY> on the IRC-6.
2. Press <%>.
3. Press <+> or <-> to either increase or decrease sound sensitivity.

Manual Color Control

To choose a specific color with the IRC-6:

1. Press <MANUAL> on the IRC-6.
2. Press any number between <0> and <9> to choose your color.

To manually control the RGB percentage:

1. Press <MANUAL> on the IRC-6.
2. Press <R>, <G>, or (red, green, or blue) to choose your color.

Note: The Freedom™ Par Tri-6 only contains red, green, and blue LEDs. The amber, white, and UV color options on the IRC-6 will only operate with fixtures capable of outputting these color lights.

3. Press <+> or <-> to increase or decrease the percentage of each color.

Miscellaneous Operation

To adjust the strobe rate of the program:

1. Press <STROBE> on the IRC-6.
2. Press <+> or <-> to increase or decrease the strobe rate.
3. Press <STROBE> again to turn off the strobe.

To choose a fade auto program:

- Press <FADE> repeatedly on the IRC-6 to choose between the two auto program fade options

To black out the lights:

- Press <BLACK OUT> on the IRC-6. This will turn off all the lights until the button is pressed again.

Note: The IRC-6 will not respond to any inputs when the Black Out mode is activated. If the remote does not respond when a button is pressed, try pressing <BLACK OUT>. You may have inadvertently activated the Black Out mode.

For Battery Function and Charge

The unit has the function of battery powered. The button for battery and charge is set on the rear panel. It is showed as the following picture, and the function is described as below.

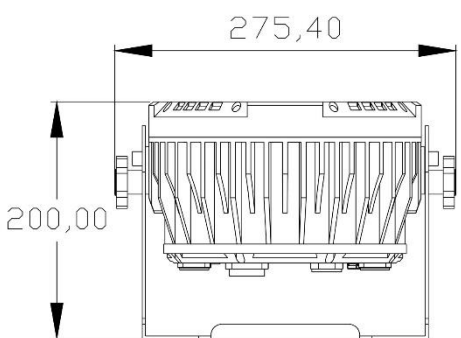
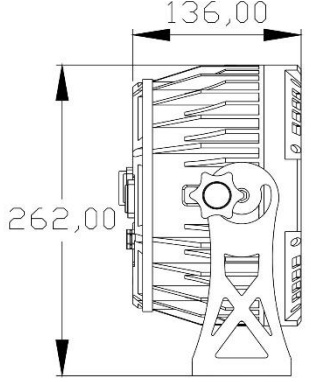
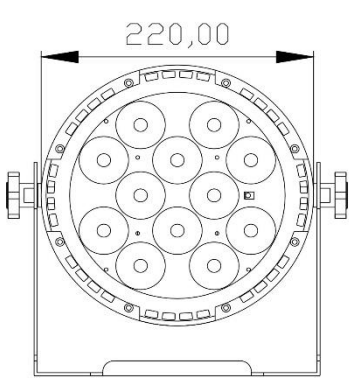
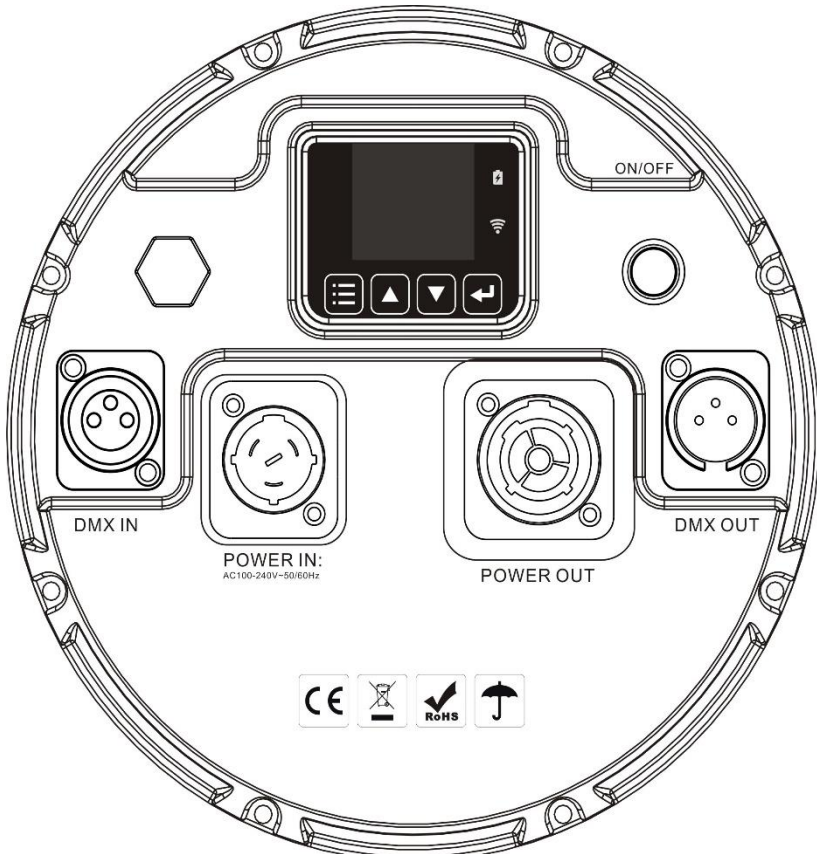

- Fuse standard is 2A/250V
- Grounded using yellow/green line
- The ambient temperature must always be under +35° C

Set Up

Power Supply: Before plugging your unit in, be sure the source voltage in your area matches the required voltage for your light is workable in 100-220V/50~60Hz. Because line voltage may vary from venue to venue, you should be sure your unit voltage matches the wall outlet voltage before attempting to operate you fixture.

Operating Instructions

Operating Modes: You can use this lighting in 5 ways:

- Sound activation – The unit will activated by the sound signal.
- Static display – The unit will display the color in static way.
- Auto Mode -The unit will automatically chase through the different patterns.
- DMX control mode -This function will allow you to control the lighting with a standard DMX 512 controller.
- Battery powered – This function will allow you to control the lighting independently without any DMX cable

DMX Mode: Operating through a DMX controller give the user the freedom to create their own programs tailored to their own individual needs. This function also allows you to use your fixtures as pattern changing lights.

1. This function will allow you to control each individual fixtures traits with a standard DMX 512 controller.

2. this lighting use 6/10 DMX channels to operate. Please see “DMX channel and Functions” for the DMX traits.

3. To run your fixture in DMX mode, plug in the fixture via the XLR connections to any standard DMX controller. Set your desired DMX address following the setup specifications that come with your DMX controller.

4. The unit can automatically recognize the DMX signal once the DMX connection is done.

DMX Linking:

To ensure proper DMX data transmission, when using several DMX fixtures try to use the shortest cable path possible. The order in which fixtures are connected in a DMX line does not influence the DMX addressing. For example; a fixture assigned a DMX address of 1 may be placed anywhere in a DMX line, at the beginning, at the end, or anywhere in the middle. When a fixture is assigned a DMX address of 1, the DMX controller knows to send DATA assigned to address 1 to that unit, no matter where it is located in the DMX chain.